





CC1

A mm ²				MINI 	MINI 
16*	32P10	CC1-4-16	HCPK4	CC1-3-16	HCPK3
25	32P10	CC1-4-25	HCPK4	CC1-3-25	HCPK3
35	32P10	CC1-4-35	HCPK4	CC1-3-35	HCPK3
50	45P10	CC1-4-50	HCPK4	CC1-3-50	HCPK3
8mm Ø	45P10	CC1-4-8SC	HCPK4	CC1-3-8SC	HCPK3
70	65P10	CC1-4-70	HCPK4	CC1-3-70	HCPK3
10mm Ø	65P10	CC1-4-10SC	HCPK4	CC1-3-10SC	HCPK3
95	90P10	CC1-4-95	HCPK4	CC1-3-95	HCPK3
120	115P10	CC1-4-120	HCPK4	CC1-3-120	HCPK3
150	115P10	CC1-4-150	HCPK4	CC1-3-150	HCPK3
185	150P10	CC1-4-185	HCPK4	-	-
240	200P10	CC1-4-240	HCPK4	-	-
300	250P10	CC1-4-300	HCPK4	-	-
400	2 x 150P10	CC1-5-400	HCPK5	-	-



A

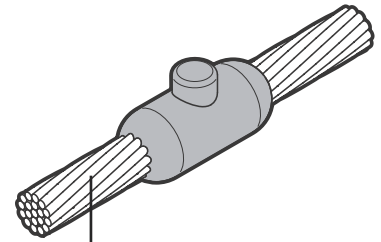

*  2 x S103

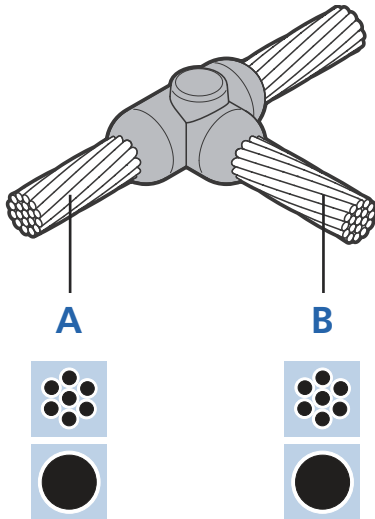





CC2

A mm ²	B mm ²					
16*	16*	45P10	CC2-4-1616	HCPK4	CC2-3-1616	HCPK3
25	25	45P10	CC2-4-2525	HCPK4	CC2-3-2525	HCPK3
35	35	45P10	CC2-4-3535	HCPK4	CC2-3-3535	HCPK3
35	25	45P10	CC2-4-3525	HCPK4	CC2-3-3525	HCPK3
8mm Ø	8mm Ø	65P10	CC2-4-885C	HCPK4	CC2-3-885C	HCPK3
50	50	90P10	CC2-4-5050	HCPK4	CC2-3-5050	HCPK3
50	35	65P10	CC2-4-5035	HCPK4	CC2-3-5035	HCPK3
50	25	65P10	CC2-4-5025	HCPK4	CC2-3-5025	HCPK3
10mm Ø	10mm Ø	90P10	CC2-4-1010SC	HCPK4	CC2-3-1010SC	HCPK3
70	70	90P10	CC2-4-7070	HCPK4	CC2-3-7070	HCPK3
70	50	90P10	CC2-4-7050	HCPK4	CC2-3-7050	HCPK3
70	35	65P10	CC2-4-7035	HCPK4	CC2-3-7035	HCPK3
70	25	65P10	CC2-4-7025	HCPK4	CC2-3-7025	HCPK3
95	95	115P10	CC2-4-9595	HCPK4	CC2-3-9595	HCPK3
95	70	90P10	CC2-4-9570	HCPK4	CC2-3-9570	HCPK3
95	50	90P10	CC2-4-9550	HCPK4	CC2-3-9550	HCPK3
95	35	90P10	CC2-4-9535	HCPK4	CC2-3-9535	HCPK3
120	120	150P10	CC2-4-120120	HCPK4	-	-
120	95	150P10	CC2-4-12095	HCPK4	-	-
120	70	90P10	CC2-4-12070	HCPK4	CC2-3-12070	HCPK3
120	50	90P10	CC2-4-12050	HCPK4	CC2-3-12050	HCPK3
150	150	200P10	CC2-4-150150	HCPK4	-	-
150	120	150P10	CC2-4-150120	HCPK4	-	-
150	95	150P10	CC2-4-15095	HCPK4	-	-
150	70	90P10	CC2-4-15070	HCPK4	CC2-3-15070	HCPK3
185	185	200P10	CC2-4-185185	HCPK4	-	-
185	150	200P10	CC2-4-185150	HCPK4	-	-
185	120	200P10	CC2-4-185120	HCPK4	-	-
185	95	150P10	CC2-4-18595	HCPK4	-	-
240	240	2 x 150P10	CC2-4-240240	HCPK4	-	-
240	185	200P10	CC2-4-240185	HCPK4	-	-
240	150	200P10	CC2-4-240150	HCPK4	-	-
240	120	200P10	CC2-4-240120	HCPK4	-	-
300	300	2 x 200P10	CC2-5-300300	HCPK5	-	-
300	240	2 x 200P10	CC2-5-300240	HCPK5	-	-
300	185	250P10	CC2-4-300185	HCPK4	-	-

*  3 x S103

CC4

A mm ²	B mm ²				MINI 	MINI 
16*	16*	65P10	CC4-4-1616	HCPK4	CC4-3-1616	HCPK3
25	25	45P10	CC4-4-2525	HCPK4	CC4-3-2525	HCPK3
35	35	65P10	CC4-4-3535	HCPK4	CC4-3-3535	HCPK3
35	25	65P10	CC4-4-3525	HCPK4	CC4-3-3525	HCPK3
8mm Ø	8mm Ø	90P10	CC4-4-885C	HCPK4	CC4-3-885C	HCPK3
50	50	90P10	CC4-4-5050	HCPK4	CC4-3-5050	HCPK3
50	35	90P10	CC4-4-5035	HCPK4	CC4-3-5035	HCPK3
50	25	90P10	CC4-4-5025	HCPK4	CC4-3-5025	HCPK3
10mm Ø	10mm Ø	115P10	CC4-4-10105C	HCPK4	CC4-3-10105C	HCPK3
70	70	115P10	CC4-4-7070	HCPK4	CC4-3-7070	HCPK3
70	50	115P10	CC4-4-7050	HCPK4	CC4-3-7050	HCPK3
70	35	115P10	CC4-4-7035	HCPK4	CC4-3-7035	HCPK3
70	25	115P10	CC4-4-7025	HCPK4	CC4-3-7025	HCPK3
95	95	150P10	CC4-4-9595	HCPK4	-	-
95	70	150P10	CC4-4-9570	HCPK4	-	-
95	50	115P10	CC4-4-9550	HCPK4	-	-
95	35	115P10	CC4-4-9535	HCPK4	-	-
120	120	200P10	CC4-4-120120	HCPK4	-	-
120	95	200P10	CC4-4-12095	HCPK4	-	-
120	70	150P10	CC4-4-12070	HCPK4	-	-
120	50	150P10	CC4-4-12050	HCPK4	-	-
150	150	250P10	CC4-4-150150	HCPK4	-	-
150	120	250P10	CC4-4-150120	HCPK4	-	-
150	95	200P10	CC4-4-15095	HCPK4	-	-
150	70	150P10	CC4-4-15070	HCPK4	-	-
185	185	2 x 150P10	CC4-4-185185	HCPK4	-	-
185	150	250P10	CC4-4-185150	HCPK4	-	-
185	120	250P10	CC4-4-185120	HCPK4	-	-
185	95	200P10	CC4-4-18595	HCPK4	-	-
185	70	200P10	CC4-4-18570	HCPK4	-	-
240	240	2 x 250P10	CC4-5-240240	HCPK5	-	-
240	185	2 x 200P10	CC4-5-240185	HCPK5	-	-
240	150	2 x 200P10	CC4-5-240150	HCPK5	-	-
240	120	2 x 150P10	CC4-5-240120	HCPK5	-	-

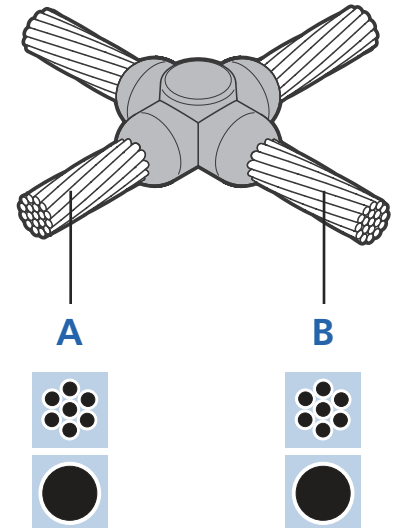

*  4 x S103

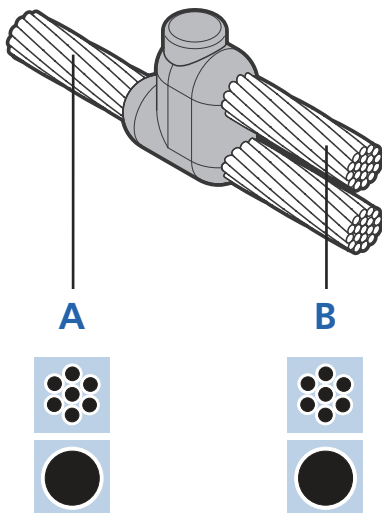





CC6

A mm ²	B mm ²					
16*	16*	65P10	CC6-4-1616	HCPK4	CC6-3-1616	HCPK3
25	25	45P10	CC6-4-2525	HCPK4	CC6-3-2525	HCPK3
35	35	65P10	CC6-4-3535	HCPK4	CC6-3-3535	HCPK3
35	25	65P10	CC6-4-3525	HCPK4	CC6-3-3525	HCPK3
50	50	90P10	CC6-4-5050	HCPK4	CC6-3-5050	HCPK3
50	35	65P10	CC6-4-5035	HCPK4	CC6-3-5035	HCPK3
50	25	65P10	CC6-4-5025	HCPK4	CC6-3-5025	HCPK3
70	70	115P10	CC6-4-7070	HCPK4	CC6-3-7070	HCPK3
70	50	115P10	CC6-4-7050	HCPK4	CC6-3-7050	HCPK3
70	35	90P10	CC6-4-7035	HCPK4	CC6-3-7035	HCPK3
70	25	90P10	CC6-4-7025	HCPK4	CC6-3-7025	HCPK3
95	95	150P10	CC6-4-9595	HCPK4	-	-
95	70	115P10	CC6-4-9570	HCPK4	CC6-3-9570	HCPK3
95	50	115P10	CC6-4-9550	HCPK4	CC6-3-9550	HCPK3
95	35	115P10	CC6-4-9535	HCPK4	CC6-3-9535	HCPK3
120	120	200P10	CC6-4-120120	HCPK4	-	-
120	95	200P10	CC6-4-12095	HCPK4	-	-
120	70	150P10	CC6-4-12070	HCPK4	-	-
120	50	115P10	CC6-4-12050	HCPK4	CC6-3-12050	HCPK3

* 3 x S103

CC7

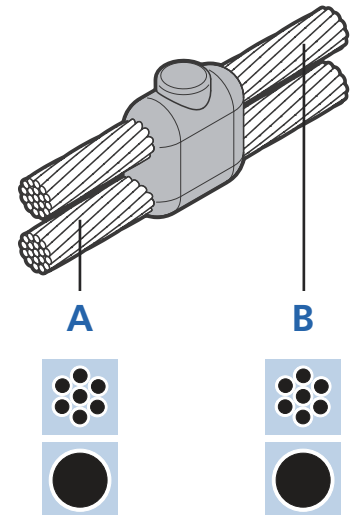

A mm ²	B mm ²				MINI 	MINI 
16*	16*	65P10	CC7-4-1616	HCPK4	CC7-3-1616	HCPK3
25	25	45P10	CC7-4-2525	HCPK4	CC7-3-2525	HCPK3
35	35	65P10	CC7-4-3535	HCPK4	CC7-3-3535	HCPK3
35	25	65P10	CC7-4-3525	HCPK4	CC7-3-3525	HCPK3
8mm Ø	8mm Ø	90P10	CC7-4-885C	HCPK4	CC7-3-885C	HCPK3
50	50	90P10	CC7-4-5050	HCPK4	CC7-3-5050	HCPK3
50	35	90P10	CC7-4-5035	HCPK4	CC7-3-5035	HCPK3
50	25	65P10	CC7-4-5025	HCPK4	CC7-3-5025	HCPK3
10mm Ø	10mm Ø	115P10	CC7-4-10105C	HCPK4	CC7-3-10105C	HCPK3
70	70	115P10	CC7-4-7070	HCPK4	CC7-3-7070	HCPK3
70	50	115P10	CC7-4-7050	HCPK4	CC7-3-7050	HCPK3
70	35	90P10	CC7-4-7035	HCPK4	CC7-3-7035	HCPK3
70	25	90P10	CC7-4-7025	HCPK4	CC7-3-7025	HCPK3
95	95	150P10	CC7-4-9595	HCPK4	-	-
95	70	115P10	CC7-4-9570	HCPK4	CC7-3-9570	HCPK3
95	50	115P10	CC7-4-9550	HCPK4	CC7-3-9550	HCPK3
95	35	115P10	CC7-4-9535	HCPK4	CC7-3-9535	HCPK3
120	120	200P10	CC7-4-120120	HCPK4	-	-
120	95	200P10	CC7-4-12095	HCPK4	-	-
120	70	150P10	CC7-4-12070	HCPK4	-	-
120	50	150P10	CC7-4-12050	HCPK4	-	-
150	150	2 x 150P10	CC7-5-150150	HCPK5	-	-
150	120	250P10	CC7-4-150120	HCPK4	-	-
150	95	200P10	CC7-4-15095	HCPK4	-	-
150	70	150P10	CC7-4-15070	HCPK4	-	-
185	185	2 x 150P10	CC7-5-185185	HCPK5	-	-
185	150	2 x 150P10	CC7-5-185150	HCPK5	-	-
185	120	250P10	CC7-4-185120	HCPK4	-	-
185	95	200P10	CC7-4-18595	HCPK4	-	-
240	240	2 x 200P10	CC7-5-240240	HCPK5	-	-
240	185	2 x 200P10	CC7-5-240185	HCPK5	-	-
240	150	2 x 150P10	CC7-5-240150	HCPK5	-	-
240	120	250P10	CC7-4-240120	HCPK4	-	-
300	300	2 x 250P10	CC7-5-300300	HCPK5	-	-
300	240	2 x 250P10	CC7-5-300240	HCPK5	-	-
300	185	2 x 200P10	CC7-5-300185	HCPK5	-	-
300	150	2 x 150P10	CC7-5-300150	HCPK5	-	-

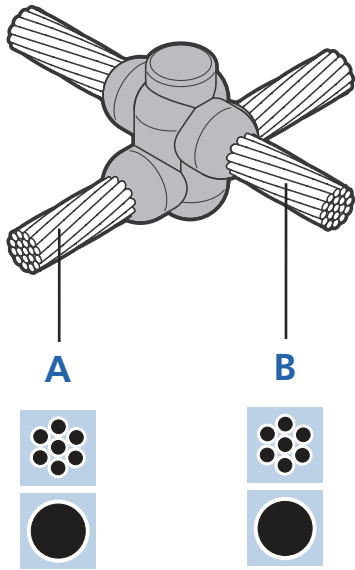

*  4 x S103







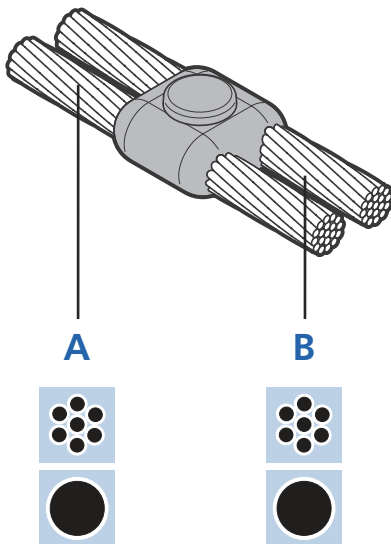

CC11

A mm ²	B mm ²			
50	50	150P10	CC11-7-5050	HCPK7
70	70	200P10	CC11-7-7070	HCPK7
95	95	250P10	CC11-7-9595	HCPK7
120	120	2 x 150P10	CC11-7-120120	HCPK7
150	150	2 x 200P10	CC11-8-150150	HCPK8
185	185	2 x 250P10	CC11-8-185185	HCPK8
240	240	3 x 250P10	CC11-8-240240	HCPK8
8mm Ø	8mm Ø	150P10	CC11-7-8SC8SC	HCPK7
10mm Ø	10mm Ø	150P10	CC11-7-1010SC	HCPK7



CC14

A mm ²	B mm ²					
16*	16*	65P10	CC14-4-1616	HCPK4	CC14-3-1616	HCPK3
25	25	45P10	CC14-4-2525	HCPK4	CC14-3-2525	HCPK3
35	35	65P10	CC14-4-3535	HCPK4	CC14-3-3535	HCPK3
35	25	65P10	CC14-4-3525	HCPK4	CC14-3-3525	HCPK3
8mm Ø	8mm Ø	90P10	CC14-4-88SC	HCPK4	CC14-3-88SC	HCPK3
50	50	90P10	CC14-4-5050	HCPK4	CC14-3-5050	HCPK3
50	35	90P10	CC14-4-5035	HCPK4	CC14-3-5035	HCPK3
50	25	90P10	CC14-4-5025	HCPK4	CC14-3-5025	HCPK3
10mm Ø	10mm Ø	115P10	CC14-4-1010SC	HCPK4	CC14-3-1010SC	HCPK3
70	70	115P10	CC14-4-7070	HCPK4	CC14-3-7070	HCPK3
70	50	115P10	CC14-4-7050	HCPK4	CC14-3-7050	HCPK3
70	35	90P10	CC14-4-7035	HCPK4	CC14-3-7035	HCPK3
70	25	90P10	CC14-4-7025	HCPK4	CC14-3-7025	HCPK3
95	95	150P10	CC14-4-9595	HCPK4	-	-
95	70	150P10	CC14-4-9570	HCPK4	-	-
95	50	150P10	CC14-4-9550	HCPK4	-	-
95	35	115P10	CC14-4-9535	HCPK4	CC14-3-9535	HCPK3
120	120	200P10	CC14-4-120120	HCPK4	-	-
120	95	200P10	CC14-4-12095	HCPK4	-	-
120	70	200P10	CC14-4-12070	HCPK4	-	-
120	50	150P10	CC14-4-12050	HCPK4	-	-

*  4 x S103