

Switched on
street lighting





lucy

fused products

The Lucy fused product range features the popular Trojan street lighting isolators, the Titan range of street lighting cut outs with many class-leading features, and the MC040SLF single phase cut out – a simple yet reliable and hardwearing unit.

trojan

Street lighting isolators

Lucy zodion's Trojan isolators deliver optimum versatility with a wealth of practical features that make them a popular choice both with Local Authorities and contractors. Presented in 2, 3 and 4 way modular format, they cater for a variety of applications that require double pole isolation in a compact yet robust housing. Units are typically supplied with an isolator and fuses but can be configured with DIN rail mounting modules of the Customer's choice thanks to the in-house design and build service.



trojan2 midi

2/3 way modular system



INTRODUCING...

the NEW Trojan2 Midi, 2/3 way modular system that replaces the Trojan Midi.

Meticulous attention to detail results in the compact dimensions of the latest addition to the Trojan range. Equipped with a 32A DP isolator and a 25A fuse carrier featuring an interlock device that automatically slides over the fuse carrier(s) when the isolator is moved to the ON position ensuring that a fuse carrier cannot be opened with the circuit energised. Both the Lucy isolator and the Lucy fuse carrier have been third party tested at KEMA laboratories to their relevant standards. A removable blank enables an extra module to be incorporated if desired.

Features

Durable, robust thermoplastic enclosure with good anti-tracking properties

Cage type terminals with serrated bores and combi-head pinching screws in control / protection modules

Downward oriented lantern cable grommets to provide drip arrest

Isolator supply terminals accept up to 1 x 10mm² solid / stranded conductors

Insulated gland plate with 2 x 25mm cable entries via PVC conical grommets

Pre-loaded cross head corrosion resistant fixing screws

Fuse carrier terminals accept up to 25mm² conductors

Lockable fuse carrier and transparent front access cover

Rail mounted earth terminal accepts 3 x 10mm² conductors

Shrouded test probe access to incoming and outgoing control module terminals

Specification

1 x 32A DP isolator, 1 x 25A BS88 fuse carrier, 1 x Earth terminal block, Insulated gland plate with 2 x 25mm entries

Trough/gland options

The Trojan2 Midi isolator is compatible with the Lucy Titan2 range of troughs and gland plates. (See pages 98 and 99)

Conformity to Standards

Fuse carrier KEMA tested to IEC/EN 60269-1

DP isolator KEMA tested to IEC/EN 60947-3

IP rating according to BSEN 60529

Accepts fuse links to BS 88 Part 1

Dimensions

Height: 173mm
Width: 90mm
Depth: 80mm

Weight

Net weight (without fuses)
0.41kg

trojan2 midi

popular products guide

Below are common Trojan2 Midi variants.

Other options are available to special order. Please refer to the full Product Range on page 104 and contact Lucy zodion Sales to discuss your requirements. Gland plates and troughs are also available separately.

Trojan Midi (NTM02) single head column 32A isolator, 1 x BS88 fuse carrier, internal earth block and plastic plate with:					
	Fuseways	Cable Entry		Description	Order Code
	1		2 x 20mm grommets & 300mm tails	NTM02-NEB2-NG06-300mm tails	THM0014962
Trojan Midi (NTM02) single head column 32A isolator, 1 x BS88 fuse carrier, internal earth block and brass plate with:					
	1		2 x 20mm grommets	NTM02-NEB2-NG12	THM0028116
	1		2 x BW20 brass glands	NTM02-NEB2-NG18	THM0037038
	1		2 x 20mm tubes	NTM02-NEB2-NG25	THM0028202
Trojan Midi (NTM02) single head column 32A isolator, 1 x BS88 fuse carrier, internal earth, small 2-way extension trough and brass plate with:					
	1		2 x 20mm grommets	NTM02-NEB2-NEF-NG12	THM0029353
	1		2 x BW20 brass glands	NTM02-NEB2-NEF-NG18	THM0022949
	1		2 x 20mm tubes	NTM02-NEB2-NEF-NG25	THM0037052
Trojan Midi (NTM02) single head column 32A isolator, 1 x BS88 fuse carrier, internal earth, large 2-way extension trough and brass plate with:					
	1		2 x 20mm grommets	NTM02-NEB2-DRT2-NG12	THM0035640
	1		2 x 25mm grommets	NTM02-NEB2-DRT2-NG13	THM0037084
	1		2 x BW20 brass glands	NTM02-NEB2-DRT2-NG18	THM0037096
	1		2 x 20mm tubes	NTM02-NEB2-DRT2-NG25	THM0028895
	1		2 x 25mm tubes	NTM02-NEB2-DRT2-NG26	THM0030635
Trojan Midi (NTM03) 2 head column 32A isolator, 2 x BS88 fuse carrier, internal earth block and plastic plate with:					
	2		2 x 20mm grommets & 300mm tails	NTM03-NEB2-NG06-300mm tails	THM0034193
Trojan Midi (NTM03) 2 head column 32A isolator, 2 x BS88 fuse carriers, internal earth block and brass plate with:					
	2		2 x 20mm grommets	NTM03-NEB2-NG12	THM0025150
	2		2 x BW20 brass glands	NTM03-NEB2-NG18	THM0032139
	2		2 x 20mm tubes	NTM03-NEB2-NG25	THM0037098
Trojan Midi (NTM03) 2 head column 32A isolator, 2 x BS88 fuse carriers, internal earth block, small extension trough and brass plate with:					
	2		2 x 20mm grommets	NTM03-NEB2-NEF-NG12	THM0028557
	2		2 x BW20 brass glands	NTM03-NEB2-NEF-NG18	THM0025447
	2		2 x 20mm tubes	NTM03-NEB2-NEF-NG25	THM0032078
Trojan Midi (NTM03) 2 head column 32A isolator, 2 x BS88 fuse carriers, internal earth & neutral block, large 2-way extension trough with 2TT LNE terminal blocks and brass plate with:					
	2		2 x 20mm grommets	NTM03-NEB2-DRT2-NG12	THM0037101
	2		2 x 25mm grommets	NTM03-NEB2-DRT2-NG13	THM0035174
	2		2 x BW20 brass glands	NTM03-NEB2-DRT2-NG18	THM0037104
	2		2 x 20mm tubes	NTM03-NEB2-DRT2-NG25	THM0037129
	2		2 x 25mm tubes	NTM03-NEB2-DRT2-NG26	THM0031135
Trojan Midi (NTM03) single head column with 1 fused spur, 32A isolator, 2 x BS88 fuse carriers, internal earth & neutral block, large 3-way extension trough with 5 terminal blocks (L, N, E, Ls, Ns) and brass plate with:					
	2		3 x 25mm tubes	NTM03-NEB2-NNB2-NEC-SP2T5-NG61	THM0020717
	2		3 x BW25 glands	NTM03-NEB2-NNB2-NEC-DXT4-NG81	THM0032098
	2		3 x 20mm tubes	NTM03-NEB2-NNB2-NEC-DXT4-NG67	THM0039459
	2		3 x BW20 glands	NTM03-NEB2-NNB2-NEC-DXT4-NG65	THM0029620

trojan2 troughs

specification



Mini Extension Trough NEF, 2 entry
 Length 34mm, Width 79mm,
 Depth 66mm



Extension Trough NEA, 3 entry
 Length 90mm, Width 98mm,
 Depth 93mm

NEA 2TT Terminal Block Arrangement



Mini Extension Trough NEE, 3 entry
 Length 38mm, Width 86mm,
 Depth 93mm

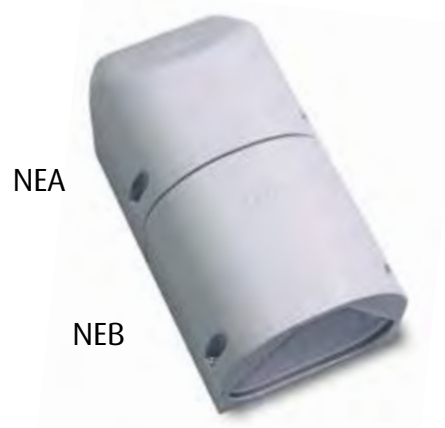

NEA

NEB

NEA Trough base

Shown fitted with 5 x 25mm² capacity insulated terminal blocks.

Extension Trough NEC, 3 entry
 Created by coupling NEA trough to NEB
 Terminals can be installed in either
 upper chamber (NEA) or lower
 chamber (NEB).
 Length 180mm, Width 98mm,
 Depth 93mm



NEA 3TT Terminal Block Arrangement



NED

**NED with 3 phase neutral
 and earth blocks**

The troughs featured above are specifically designed to enhance the versatility of the Trojan2 range, providing solutions for even the most onerous cabling situations. Manufactured from the same high performance thermoplastics as the fuse unit, the extension troughs can be fitted with a variety of terminations including insulated terminal blocks or stud terminals. (See Page 104 for details) Gland plates are available in either brass or insulated material to suit different earthing requirements.

trojan mini





2 way modular system



Built with ease of installation foremost in mind, the Trojan Mini has surprisingly generous cabling access for a product of its size. Able to accept a variety of cable types and terminations, the Trojan Mini can also be supplied pre-wired with connection leads to reduce on-site installation time.

Below are common Trojan Mini variants.

Other options are available to special order. Please refer to the full Product Range on page 105 and contact Lucy zodion Sales to discuss your requirements. Gland plates and troughs are also available separately.

Trojan Mini (TR2) 32A isolator, 1 x BS88 fuse carrier, internal earth block with:				
	Fuseways	Cable Entry	Description	Order Code
	1		Moulded plastic cable entry plate, 1 x 20mm grommet	TR2-MG25-EB1 THM0005605
	1		Removeable plastic plate, with 1 x 20mm grommet	TR2-PP20-EB1 THM0015554
	1		brass plate with, 1 x 20mm grommet	TR2-BP20-EB1 THM0022079
	1		brass plate, 1 x 20mm tube	TR2-TP20-EB1 THM0028526

Specification

32A Double Pole switched isolator KEMA tested to IEC/EN 60947-3

Safety interlock device allowing the unit to be locked in the 'OFF' position so that fuse withdrawal under load is impossible.

BS88 Fuse holder KEMA tested to IEC/EN 60269-1

IP 33D rating

Clear lockable hinged lid showing the 'ON/OFF' position

MD or LD fuses supplied separately

DIN rail mounting for modules

High grade flame retardant ABS enclosure

XTO Extension trough available for larger section cables (See page 94)

Dimensions

Height: 170mm

Width: 60mm

Depth: 83mm

trojan maxi















4 way modular system



The Maxi is the largest enclosure in the Trojan portfolio. Just like the Mini and Midi variants, the Maxi carries the same high specification equipment but with the increased versatility that 4 modules gives.

Below are common Trojan Maxi variants.

Other options are available to special order. Please refer to the full Product Range on page 106 and contact Lucy zodion Sales to discuss your requirements. Gland plates and troughs are also available separately.

Trojan Maxi (TW03) 3 head column 32A isolator, 3 x BS88 fuse carriers, internal earth & neutral block, small 2-way extension trough and brass plate with:					
	Fuseways	Cable Entry		Description	Order Code
	3		2 x 20mm grommets	TW03-EB2N1-EF-G12	THM0022441
	3		2 x 20mm tubes	TW03-EB2N1-EF-G25	THM0021968
Trojan Maxi (TW03) 3 head column 32A isolator, 3 x BS88 fuse carriers, internal earth & neutral block, large 2-way extension trough with 2TT LNE terminal blocks and brass plate with:					
	3		2 x 20mm grommets	TW03-EB2N1-ED-2T3-G12	THM0004519
	3		2 x 25mm grommets	TW03-EB2N1-ED-2T3-G13	THM0039401
	3		2 x 20mm tubes	TW03-EB2N1-ED-2T3-G25	THM0018576
	3		2 x 25mm tubes	TW03-EB2N1-ED-2T3-G26	THM0039441
Trojan Maxi (TW03) 2 head column with 1 spur, 32A isolator, 3 x BS88 fuse carriers, internal earth & neutral block, large 3-way extension trough with 2TT LNE terminal blocks and brass plate with:					
	3		2 x 25mm grommet and 1 x 20mm grommet	TW03-EB2N1-EC-T3-G52	THM0023257
	3		3 x 25mm grommets	TW03-N1-ED-EE-2T5-G53	THM0015126
	3		3 x 25mm tubes	TW03-EB2N1-ED-EE-2T5-G61	THM0011857
	3		3 x 20mm tubes	TW03-EB2N1-ED-EE-2T5-G67	THM0000364
	3		3 x 20mm grommets	TW03-EB2N1-ED-EE-2T5-G68	THM0018647
	3		3 x BW20 brass glands	TW03-EB2N1-ED-EE-2T5-G65	THM0033353

trojan festive unit

4 way modular system



Typical layout of a 4 way festive unit

Based on the Trojan Maxi enclosure, the Festive Lighting Unit accepts up to 4 DIN modules which the Customer is free to specify. Typical configurations include a combination of MCBs, RCBOs, RCDs, time clocks and contactor modules in addition to the more conventional isolating switches and fuse holders.

Lucy zodion's Design and Engineering Service is set up to source the modules, populate the units and wire them according to Customer requirements, thereby enabling the contractor to save costly on-site installation time. Extension troughs with two or three glanded cable entries can be specified to suit different cabling situations.

Typical functions that can be integrated to the Festive units include the following:

	Number of DIN modules*
SP Miniature Circuit Breaker	1
DP Miniature Circuit Breaker	1 or 2
Remote control module for mcb	1
Remote indicator module for mcb	0.5
Power-on indicator module	1
RCBO	1
Residual Current Device	2
Time clock (analogue or digital)	1
Contactors	1
Metering unit	1

*The number of modules for a given function may vary according to manufacturer. Please check for compatibility prior to placing order

Specification

Enclosure specification as per the Trojan Maxi 4 module unit.

Lucy 32A DP Isolator and BS88 Fuse Carrier

Fully conforming to their respective IEC/EN standards, the Lucy 32A Double pole isolator and BS88 fuse carrier are engineered to give reliable service in harsh environments over very long periods of time. Tested in the KEMA laboratories, they are standard fitment to all Lucy Street Lighting isolators.

Specification

32A DP Isolator

Conforms to IEC/EN 60947-3

Category of Duty: AC22B

Maximum size conductor:
16mm²

Contact gap: >3mm

BS88 Fuse Carrier

Conforms to IEC/EN 60269-1

Maximum fuse rating: 25A

Maximum size conductor:
25mm²

Cam assisted fuse extraction



trojan maxi/festive troughs



Red Extension Trough ED, 2 entry

Can be equipped with terminal blocks
See Selection chart (p106) for details.
Length 104mm, Width 78mm,
Depth 65mm.



Extension Trough EA, 3 entry

Can be equipped with terminals
See Selection chart (p106) for details.
Length 90mm, Width 90mm,
Depth 93mm



EA Trough base

Shown fitted with 25mm² capacity
insulated terminal blocks.
See Selection chart (p106) for full
range of options.



Mini Extension Trough EF, 2 entry

Length 34mm, width 79mm,
Depth 66mm

EA



EB



Extension Trough XT0, 2 entry (Trojan Mini only)

Can be equipped with terminals.
Length 120mm, Width 80mm,
Depth 65mm



Mini Extension Trough EE, 3 entry

Length 50mm, Width 86mm,
Depth 93mm

Extension Trough EC, 3 entry

Created by coupling Trough EA to EB
Terminals can only be installed in
upper chamber (EA).
See Selection chart (p106) for details.
Length 150mm, Width 90mm,
Depth 93mm

As a complement to the Trojan Midi and Maxi isolators, the troughs above provide additional space to terminate more numerous cables of a bigger section. Gland plates are available in brass or insulated material to suit different earthing configurations.

titan

Street lighting cut outs

The Titan2 Cut out is supplied as standard with many class-leading features that make the installer's task considerably easier. Take for instance the cam lever handle that enables effortless release of the fuse carrier in one movement or the generous cabling space to terminate a wide variety of conductor types and sizes. Where dual or triple entries are required, a choice of either insulated or brass gland plates is available, the latter being specifically provided for the termination of SWA cables.

High quality engineering thermoplastics make the Titan2 range the ideal choice to withstand heavy use in demanding locations.



titan2

single and double pole cut outs

fused products



Specification

Designed and tested in accordance with BS 7654:1997 and IEC/EN 60947-Part 1

Accepts fuses to IEC 269-1 and BS 88 Part 1, AC16 tag type

Moulded in high performance thermoplastics

IP43 rating

Single or Double pole

Single or Twin fuse

Detachable terminal block in extension trough facilitates termination of heavy duty cables

Electroplated brass terminal blocks accept conductors up to 25mm²

Terminal blocks for 1 to 3 conductors

Stud and lug connections

Serrated bores in terminals to ensure good contact with all conductor types

Red terminal block cover for safety

Brass or insulated gland plate options

Padlock and sealing wire facilities provided

Captive screw on cam lever

www.lucyzodion.com

Below are common Titan variants.

Other options are available to special order. Please refer to the full Product Range on page 107 and contact Lucy zodion Sales to discuss your requirements. Gland plates and troughs are also available separately.

titan2

popular products guide

fused products titan2

Titan2 (NT06) double pole single fuse cut out, complete with earth block, and brass plate with:					
	Fuseways	Cable Entry		Description	Order Code
	1		2 x 20mm grommets	NT06-TT-NG12	THM0006032
	1		2 x BW20 brass glands	NT06-TT-NG18	THM0010170
	1		2 x 20mm tubes	NT06-TT-NG25	THM0010121
	1		2 x 25mm tubes	NT06-TT-NG26	THM0031147
Titan2 (NT06) double pole single fuse cut out, complete with earth block, small extension trough, and brass plate with :					
	1		2 x 20mm grommets	NT06-TT-NEF-NG12	THM0010657
	1		2 x 25mm grommets	NT06-TT-NEF-NG13	THM0017257
	1		2 x BW20 brass glands	NT06-TT-NEF-NG18	THM0013678
	1		2 x 20mm tubes	NT06-TT-NEF-NG25	THM0010211
	1		2 x 25mm tubes	NT06-TT-NEF-NG26	THM0010212
Titan2 (NT06) double pole single fuse cut out, complete with earth block, large extension trough, and brass plate with :					
	1		2 x 25mm grommets	NT06-TT-NED-NG13	THM0036546
	1		2 x 20mm tubes	NT06-TT-NED-NG25	THM0037191
	1		2 x 25mm tubes	NT06-TT-NED-NG26	THM0028975
	1		2 x BW25 glands and 1 x 25mm grommet	NT06-TT-NEE-NG82	THM0016546
Titan2 (NT08) double pole twin fuse cut out, complete with earth block, and brass plate with :					
	2		2 x 20mm grommets	NT08-TT-NG12	THM0009901
	2		2 x BW20 brass glands	NT08-TT-NG18	THM0012689
	2		2 x 20mm tubes	NT08-TT-NG25	THM0013303
	2		2 x 25mm tubes	NT08-TT-NG26	THM0014521
Titan2 (NT08) double pole twin fuse cut out, complete with earth block, small extension trough, and brass plate with :					
	2		2 x 20mm grommets	NT08-TT-NEF-NG12	THM0010563
	2		2 x 25mm grommets	NT08-TT-NEF-NG13	THM0029334
	2		2 x BW20 brass glands	NT08-TT-NEF-NG18	THM0014659
	2		2 x 20mm tubes	NT08-TT-NEF-NG25	THM0011708
	2		2 x 25mm tubes	NT08-TT-NEF-NG26	THM0010841
Titan2 (NT08) double pole twin fuse cut out, complete with earth block, large 2-way extension trough, and brass plate with :					
	2		2 x 25mm grommets	NT08-TT-NED-NG13	THM0037298
	2		2 x 20mm tubes	NT08-TT-NED-NG25	THM0037316
	2		2 x 25mm tubes	NT08-TT-NED-NG26	THM0037323
Titan2 (NT10) double pole twin fuse cut out, complete with earth block, 3-way extension trough, and brass plate, with :					
	2		3 x 25mm tubes	NT10-NED-NEE-NT6-NG61	THM0027135
	2		3 x 20mm grommets	NT10-NEC-NT6-NG68	THM0012093
	2		2 x 25mm grommets, 1 x 20mm grommet	NT10-NEC-NT6-NG52	THM0010786

titan2 troughs



NEF Mini Extension Trough, 2 entry
Height 34mm, Width 79mm,
Depth 66mm



NEA Extension Trough, 3 entry
Height 90mm, Width 98mm,
Depth 93mm



NED Trough, 2 entry
Height 120mm, Width 83mm,
Depth 63mm



NEE Mini Extension Trough, 3 entry
Height 40mm, Width 86mm,
Depth 93mm



NEC Extension Trough, 3 entry
Created by coupling NEA trough to NEB
Terminals can be installed in either
upper chamber (NEA) or lower
chamber (NEB)
Height 180mm, Width 98mm,
Depth 93mm

The troughs featured above are specifically designed to enhance the versatility of the Titan2 range, providing solutions for even the most onerous cabling situations. Manufactured from the same high performance thermoplastics as the fuse unit, the extension troughs can be fitted with a variety of terminations including insulated terminal blocks or stud terminals. (See Page 107 for details) Gland plates are available in either brass or insulated material to suit different earthing requirements.



Ref.	Description
L1	Live feed out
L2	Second Live feed out
N	Neutral
LL	Live supply loop
NL	Neutral supply loop
LS	Live spur
NS	Neutral spur
EU	Earth block in upper chamber
EL	Earth block in lower chamber

 Symbol denoting LST Fuselink

Single Phase Single Pole
Type NT02 Loop in/out
Single Fuse

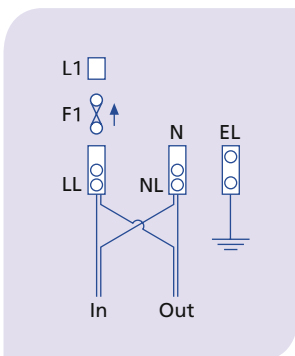

Type NT04 Loop in/out
Two Fuses

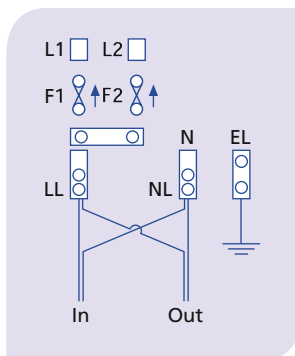

Single Phase Double Pole
Type NT06 Loop in/out
Single Fuse

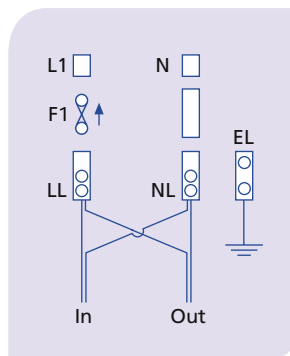

Type NT08 Loop in/out
Two Fuses

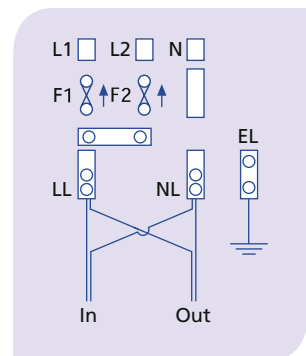

Single Phase Double Pole with Double Pole Fused Spur
Type NT10 Loop in/out with Fused Double Pole Spur

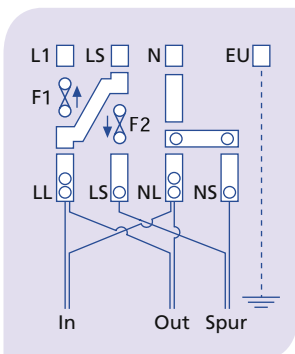

Three Phase Double Pole
Type NT12 Loop in/out
One Fuse

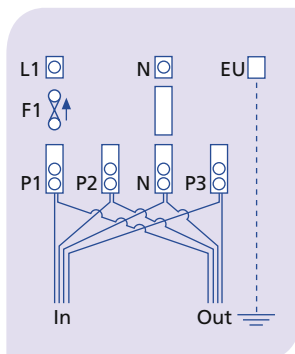

Type NT14 Loop in/out
Two Fuses fed from P1

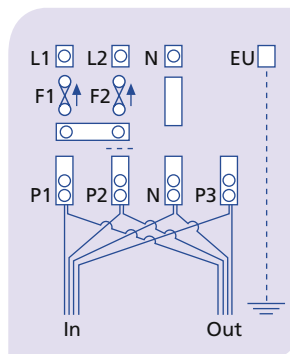

Type NT15 REC/PME Version

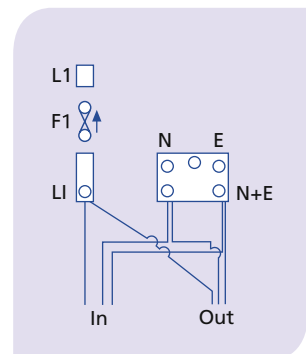

This unit will usually require use of extension trough Ref NEA with suitable gland plate

MC040SLF

single phase cut out

fused products



Two versions are available, Type 1 Separate Neutral and Earth (SNE) and Type 2 Combined Neutral / Earth (CNE) for PME applications.

With its low body split line to maximise cabling access, the SLF is the simplest exponent of the single pole Cut outs. Tough, engineering grade thermoplastics and fully electroplated brass componentry ensure that the SLF will have a long, reliable service life. Safety, as ever, is an important consideration, hence the cam operated fuse handle ensures that electrical disconnection takes place prior to the fuse carrier being extracted.

MC040SLF

single phase cut out

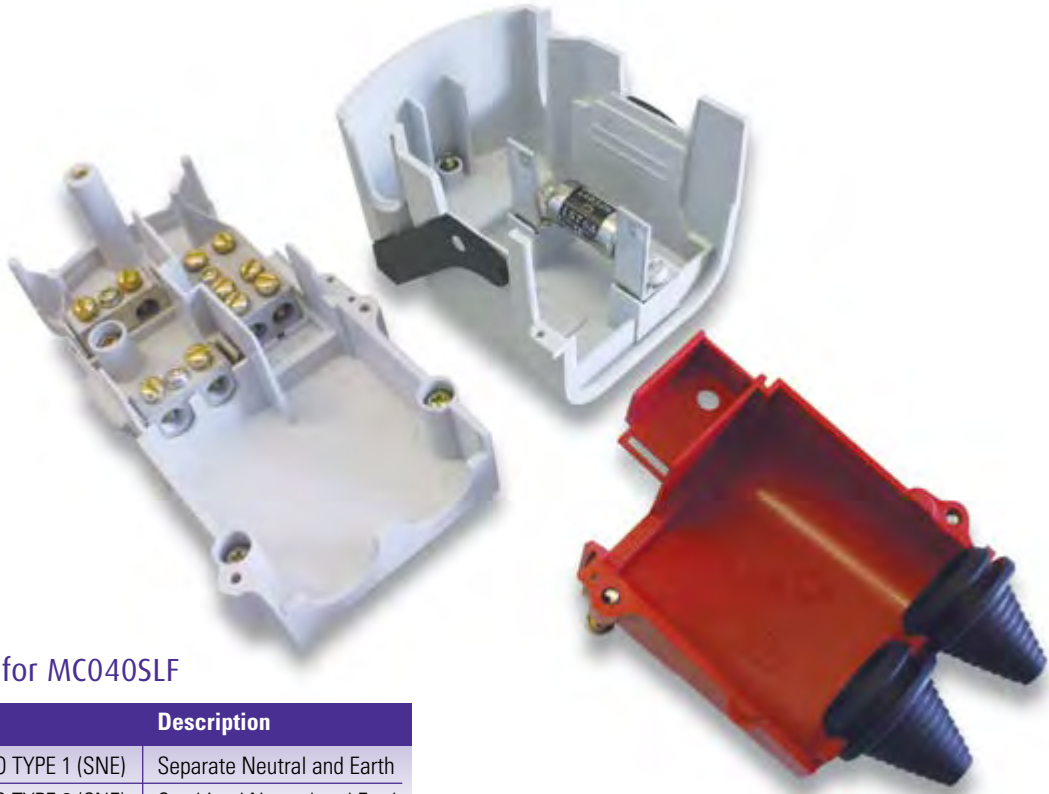

Order details for MC040SLF

Order code	Description
MC040SLF 25A SLCO TYPE 1 (SNE)	Separate Neutral and Earth
MC040SLF 25A SLCO TYPE 2 (CNE)	Combined Neutral and Earth

Fuses to fit the MC040SLF are obtainable under the following part numbers:

LST2 AMP	LST10 AMP	LST25 AMP
LST4 AMP	LST16 AMP	
LST6 AMP	LST20 AMP	

Specification

Designed and tested in accordance with BS 7654:1997

25A maximum fuse rating

Accepts fuse links to BS 88 Part 1, AC 16 tag type

IP22 rating

Single Pole isolation

Single fuse

Electroplated brass terminals with serrated bores

Maximum cable size; 16mm² stranded copper or 25mm² solid aluminium conductors

Cable entry via PVC grommets as standard

Outgoing cables exit below horizontal to form drip loop

Sealing wire facility

Dimensions

Height 150mm

Width 76mm

Depth 60mm



LST fuse

trojan and titan accessories

fused products

Standard fitment locks

All terminal blocks used in Street Lighting products are machined from solid brass which is electro-tin plated to prevent oxidation. Both solid aluminium and stranded copper conductors up to 25mm² can be utilised. The terminal bores are serrated for optimum conductivity and are fitted with brass M6 screws. Additional methods of termination include pillar terminals which again are of brass construction.

Standard fitment

2TT

2TT



3TT



Optional terminations

3TT

Brass pillar BP

BP



Gland Plates

Brass or insulated gland plates are available in one, two or three entry formats. They are able to receive 20, 25 or 32mm brass tubes for the termination of SWA cables or alternatively grommets and cable glands of the sizes indicated in the Selection charts. Internal earth leads are available with all brass gland plates.

